

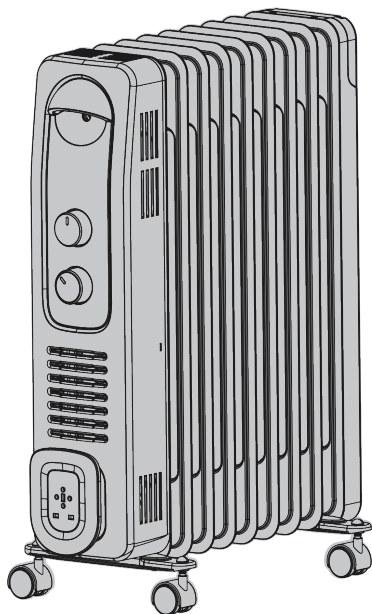

HD972-A5QL
HD972-A7QL
HD972-A9QL
HD972-A11QL



- FR** Notice de Montage - Utilisation - Entretien
- ES** Instrucciones de Montaje, Utilización y Mantenimiento
- PT** Instruções de Montagem, Utilização e Manutenção
- IT** Istruzioni per il Montaggio, l'Uso e la Manutenzione
- EL** Εγχειρίδιο συναρμολόγησης, χρήσης και συντήρησης
- PL** Instrukcja Montażu, Użytkowania i Konserwacji
- RO** Manual asamblare, utilizare și întreținere
- EN** Assembly - Use - Maintenance Manual

EAN CODE

3276000370550 3276000370628 3276000370567 3276000370635
3276000370413 3276000370642 3276000370505 3276000370512
3276000379959 3276000379980 3276000379997 3276000379935
3276000380023 3276000379973 3276000380009 3276000379911

- FR** Ce produit ne peut être utilisé que dans des locaux bien isolés ou de manière occasionnelle /
- ES** Este producto está indicado únicamente en lugares abrigados o para una utilización puntual /
- PT** Este produto é adequado apenas para espaços bem isolados ou para uma utilização ocasional /
- IT** Il presente prodotto è adatto solo a ambienti correttamente isolati o ad un uso occasionale /
- EL** Το προϊόν είναι κατάλληλο μόνο για χρήση σε καλά μονωμένους χώρους ή περιστασιακά /
- PL** Ten produkt jest odpowiedni tylko do sporadycznego użytku lub do stosowania w dobrze izolowanych pomieszczeniach /
- RO** Acest produs este adecvat numai pentru spațiile bine izolate sau pentru utilizarea ocazională /
- EN** This product is only suitable for well insulated spaces or occasional use /

Traduction de la version originale du mode d'emploi - Radiateur à huile / Traducción de las Instrucciones originales - Radiador de aceite /

Tradução das Instruções Originais - Irradiador a óleo / Traduzione delle istruzioni originali - Radiatore elettrico a olio /

Μετάφραση των πρωτότυπων οδηγιών - Καλοριφέρ λαδιού / Traduczenie instrukcji oryginalnej - Grzejnik olejowy /

Переклад оригінальної інструкції - Масляний радіатор / Traducerea instrucțiunilor originale - Radiator cu ulei /

Original Instructions - Oil Heater



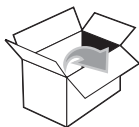

HD972-A5QL

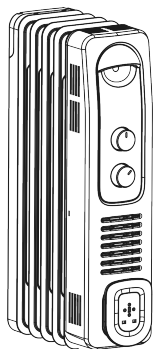

(A) x1

(B) x2

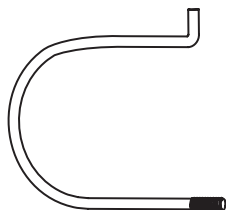
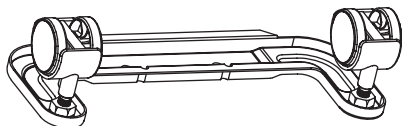

(C) x1

(D) x3



(E) x2

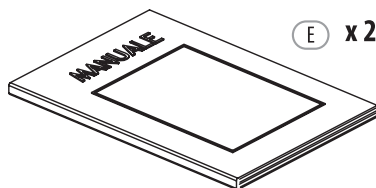

HD972-A7QL/A9QL/A11QL

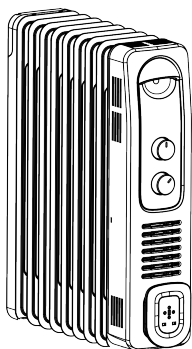

(A) x1

(B) x2

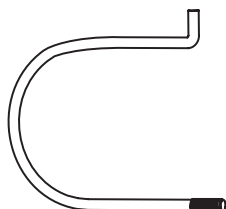

(C) x1

(D) x3



(E) x2

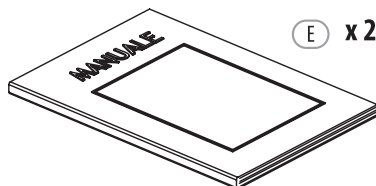



Attention danger / Atención: Peligro / Atenc o perigo / Attenzione pericolo / Προσοχή κίνδυνος / Uwaga niebezpieczestwo / Atenie, pericol / Caution danger



Observez / Atenci n / Aviso / Osservare / Προσέξτε / Przestrzega / Respectai / Observe



Nettoyage / Limpieza / Limpeza / Pulizia / Καθαρισμός / Czyszczenie / Curățare / Cleaning



Correct / Correcto / Correcto / Corretto / Σωστό / Dobrze / Corect / Correct



Incorrect / Incorrecto / Incorrecto / Errato / Λάθος / Źle / Incorect / Incorrect



Mentions légales & consignes de sécurité / Instrucciones legales y de seguridad / Avisos legais e instru es de segurana / Istruzioni legali e di sicurezza / νομικό σημείωμα και οδηγίες ασφαλείας / uwagi prawne i instrukcja bezpieczestwa / manual privind sigurana și aspectele juridice / Legal & safety instructions

**Notes / Observaciones / Notas / Note /
Σημειώσεις / Notatki / Note / Notes**

A

FR Préparation

ES Preparación

PT Preparação

IT Preparazione

EL Προετοιμασία

PL Przygotowanie

RO Pregătire

EN Preparation

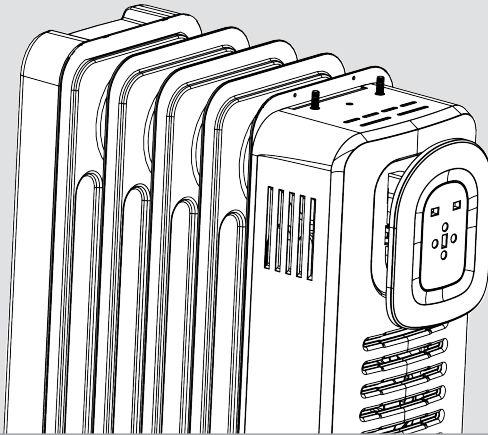
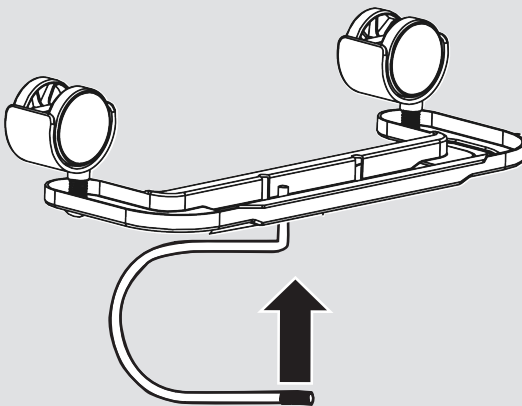
**1****HD972-A5QL****2****HD972-A5QL**



3

HD972-A5QL

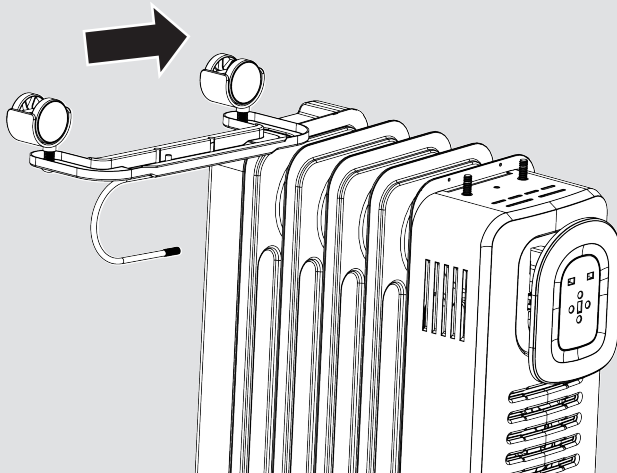

4

HD972-A5QL

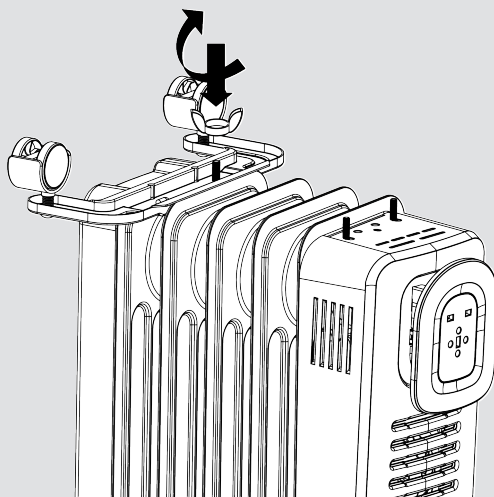

A

FR Préparation

ES Preparación

PT Preparação

IT Preparazione

EL Προετοιμασία

PL Przygotowanie

RO Pregătire

EN Preparation

5



HD972-A5QL

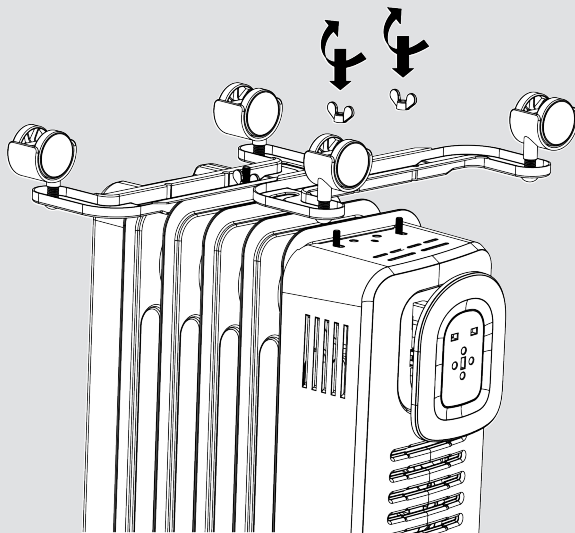

6

HD972-A5QL

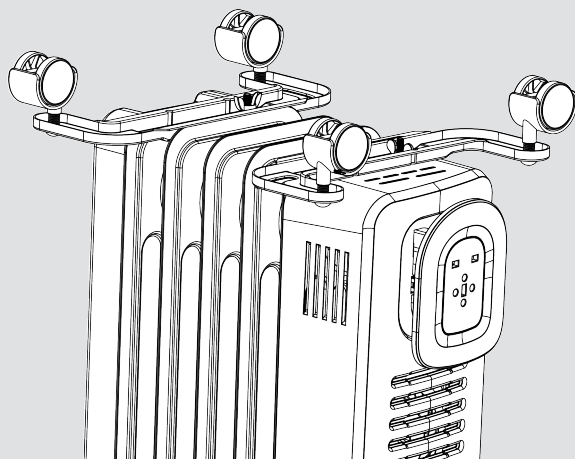



7

HD972-A7QL/A9QL/A11QL

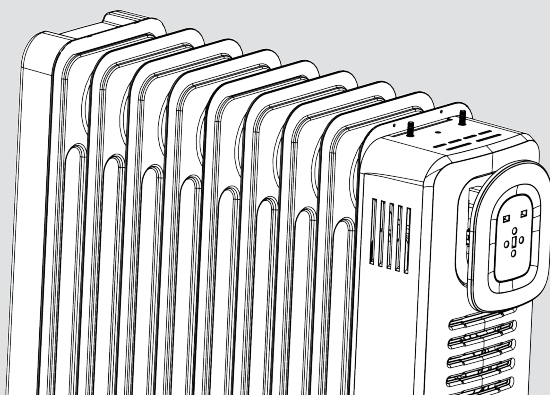

8

HD972-A7QL/A9QL/A11QL

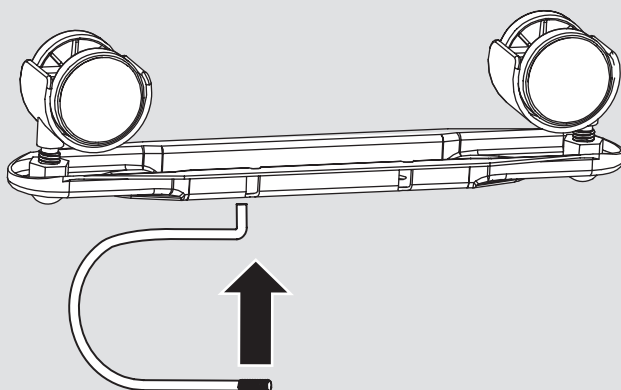

A

FR Préparation

ES Preparación

PT Preparação

IT Preparazione

EL Προετοιμασία

PL Przygotowanie

RO Pregătire

EN Preparation



9

HD972-A7QL/A9QL/A11QL

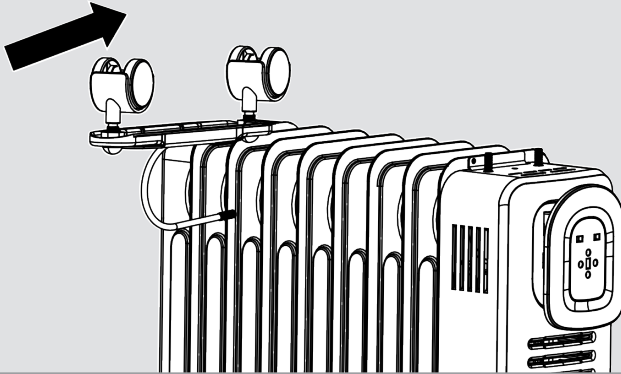

10

HD972-A7QL/A9QL/A11QL

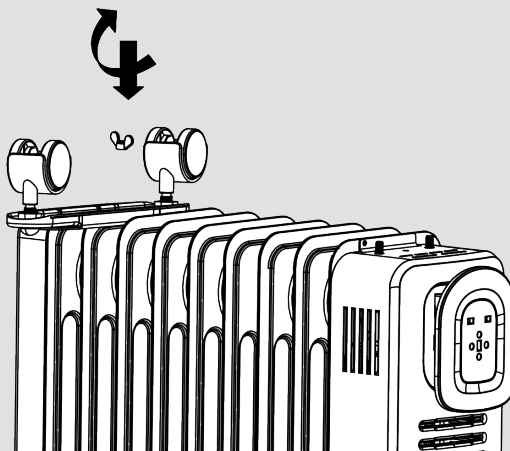



11

HD972-A7QL/A9QL/A11QL

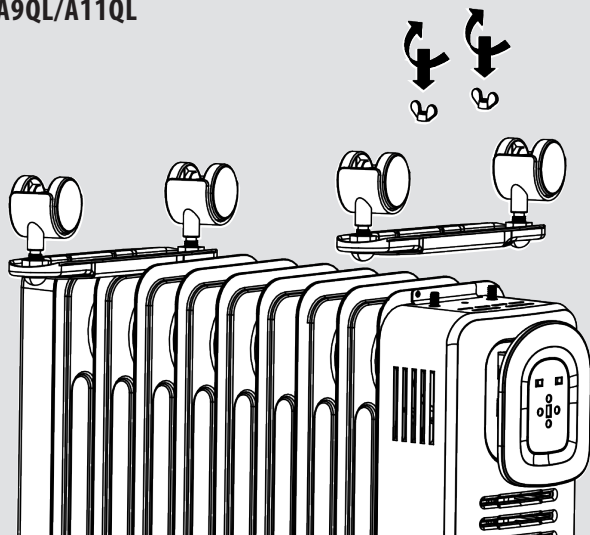

12

HD972-A7QL/A9QL/A11QL

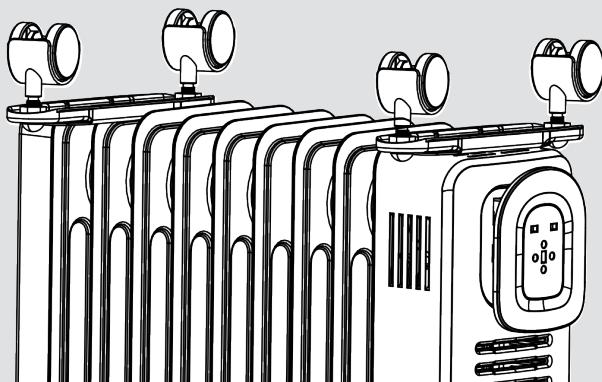

B

FR Utilisation

ES Utilización

PT Utilização

IT Uso

EL Χρήση

PL Użytkowanie

RO Utilizare

EN Use

1

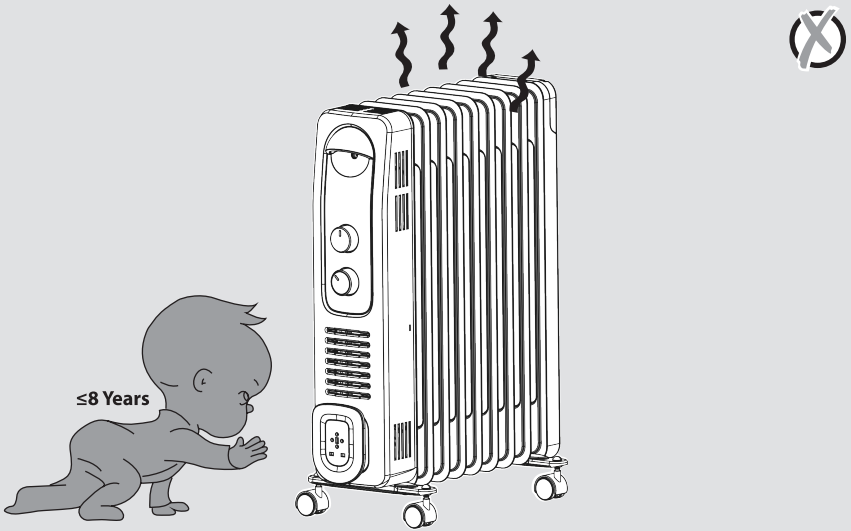

2

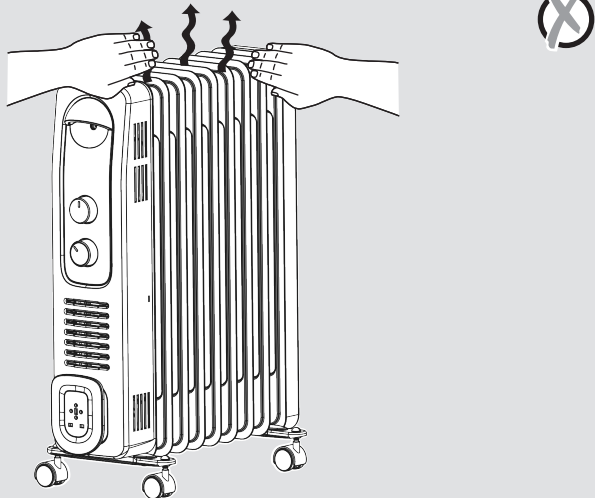

FR Utilisation

ES Utilización

PT Utilização

IT Uso

EL Χρήση

PL Użytkowanie

RO Utilizare

EN Use

B



3

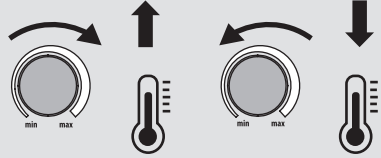
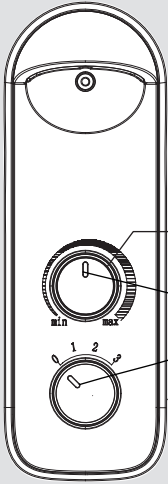

	0	1	2	3
	-	400W	600W	1000W
	-	600W	900W	1500W
	-	800W	1200W	2000W
	-	1000W	1500W	2500W

4

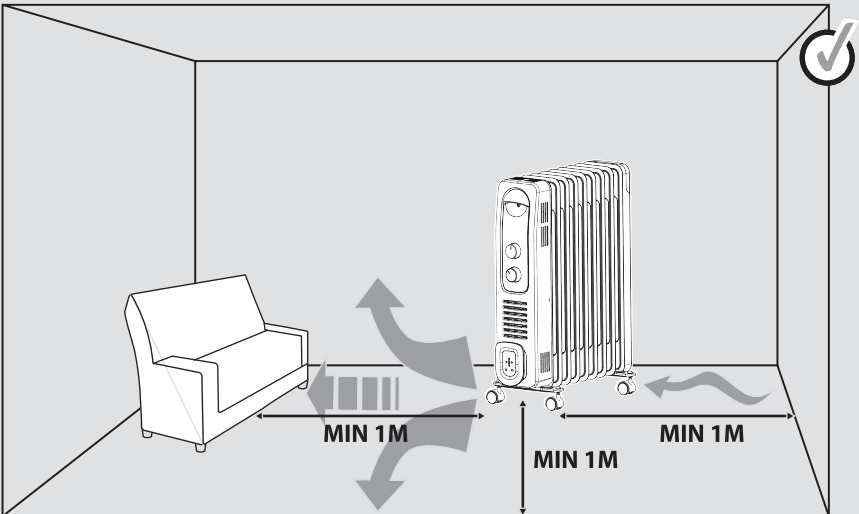

B

FR Utilisation

ES Utilización

PT Utilização

IT Uso

EL Χρήση

PL Użytkowanie

RO Utilizare

EN Use

5

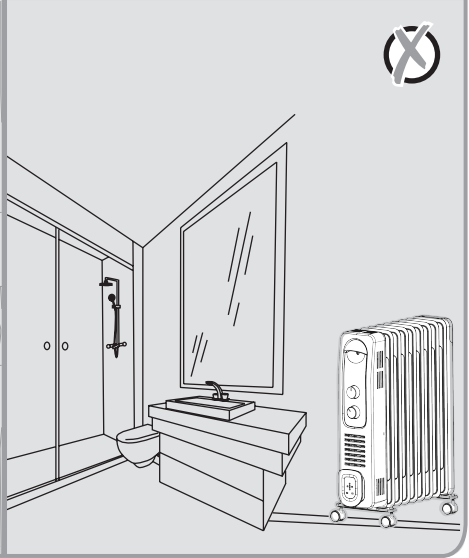
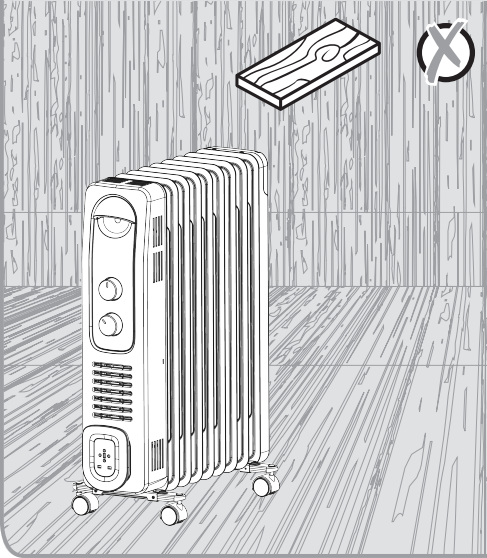

6

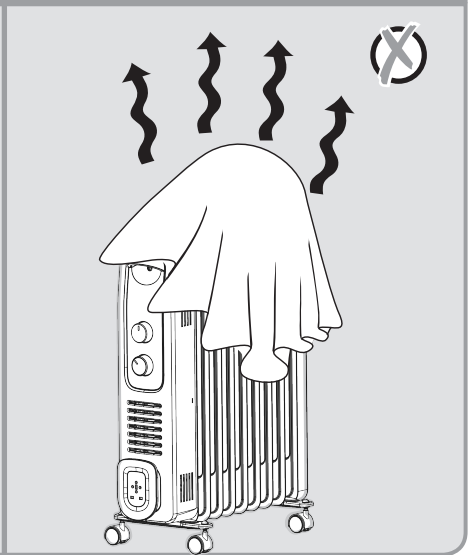
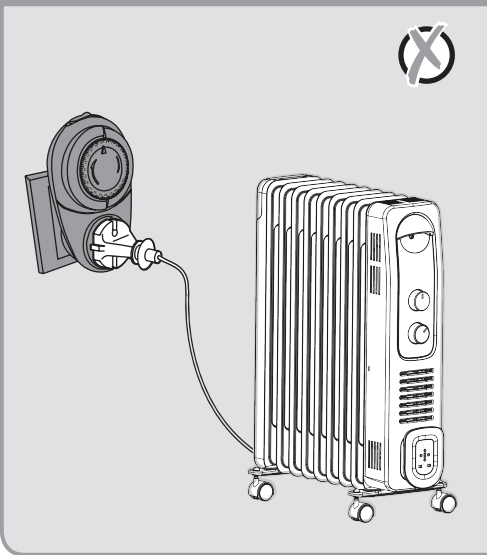

7

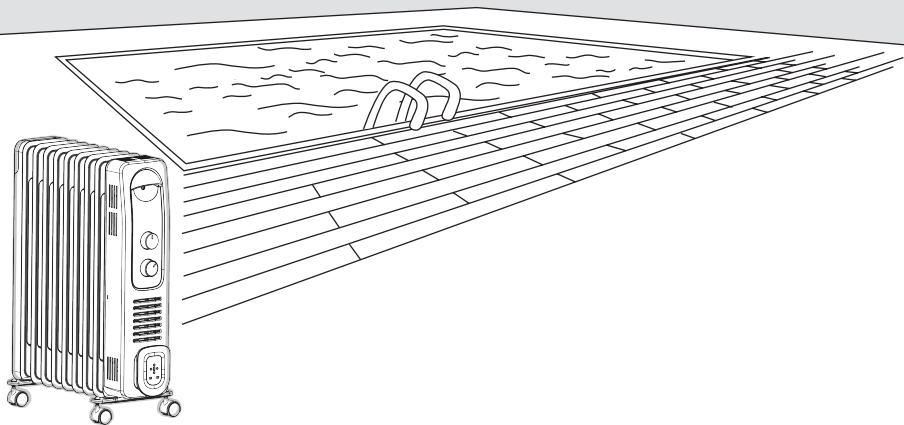

8

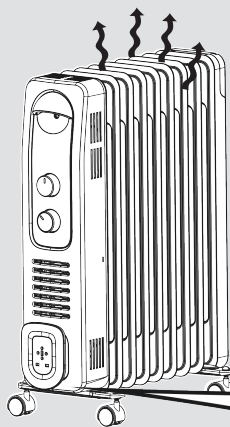
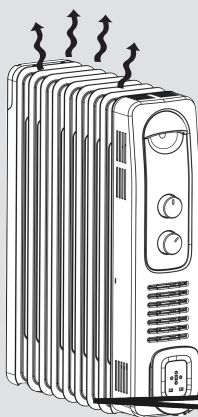

C

FR Entretien

ES Mantenimiento

PT Serviço

IT Manutenzione

EL Συντήρηση

PL Konserwacja

RO Întreținere

EN Maintenance

1

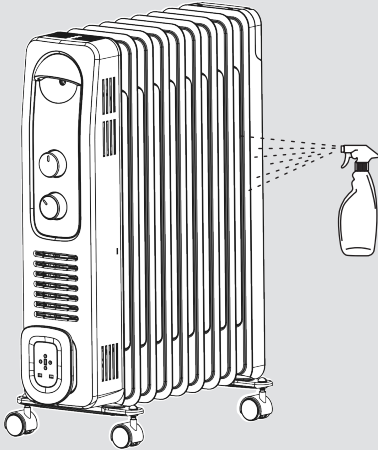

2

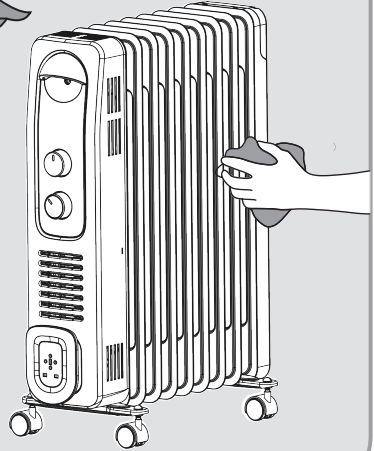

2

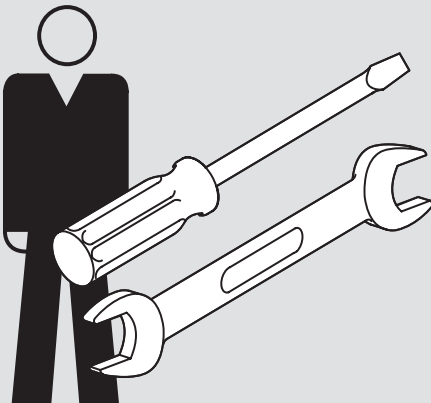

FR Hivernage

ES Durante el invierno

PT Preparação para o inverno

IT Rimessaggio

EL Αποθήκευση το χειμώνα

PL Przechowywanie

RO Păstrare pe perioada iernii

EN Winter storage

D

1

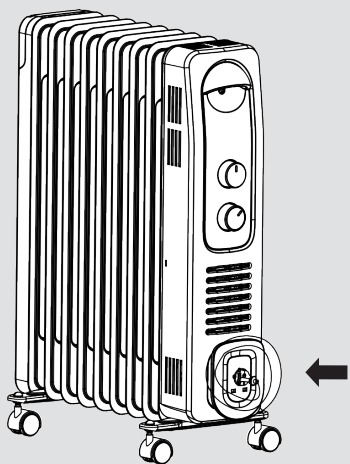

2

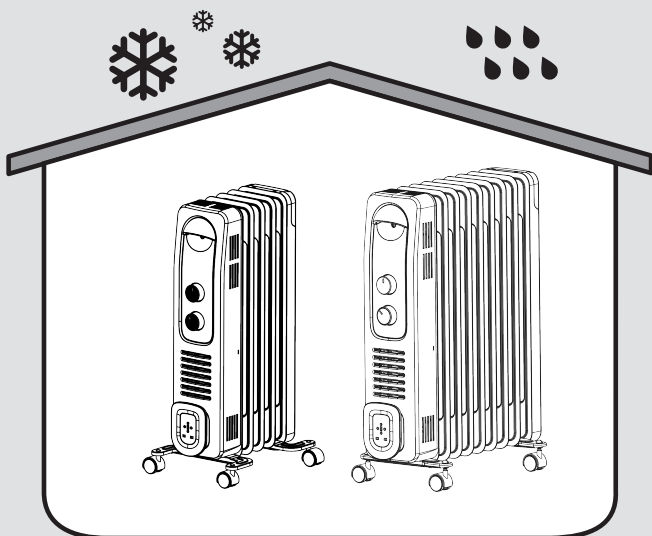

* Garantie 2 ans / 2 años de garantía / Garantia de 2 anos /
Garanzia 2 Anni / Εγγύηση 2 ετών / Gwarancja 2-letnia /
Гарантія 2 років / Garanție 2 ani / 2-year guarantee



FR ADEO Services - 135 Rue Sadi Carnot - CS 00001
59790 RONCHIN - France

RU ООО ЛЕРУА МЕРЛЕН ВОСТОК, 141031, Московская область,
Мытищинский район, г. Мытищи, Осташковское шоссе,
д. 1, РОССИЯ

UA ТОВ «Леруа Мерлен Україна»,
вул. Полярна 17а, м. Київ 04201, Україна

Made in P.R. C. 2018

